

Varenummer: 201581M840MTH1
 Beskrivelse: E+G Bolt GN 1582-M8-40-MT-H-1
 Hygiejnisk design

Mål

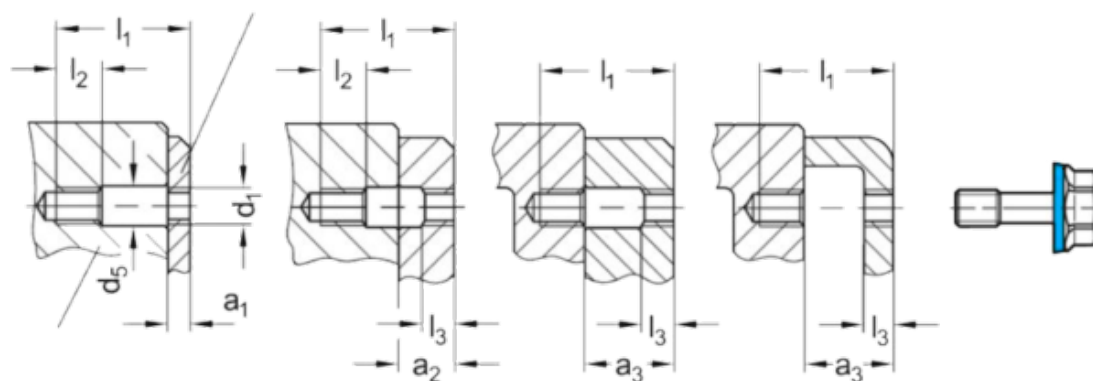
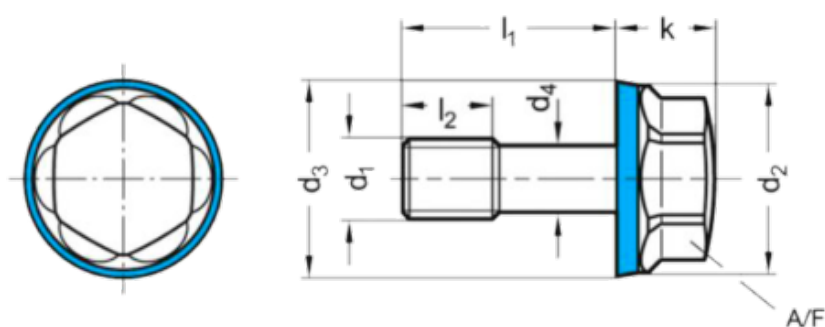

a1	= 8-18	l1	= 40
a2	= 18-25	l2	= 10
a3	= 25-30	l3	= 4
AF	= 13	Vægt	= 21
d3	= 16.8		
d4	-0,2 = -		
d5	= 8.5		
k	= 8.5		